



KOLBON

OAK CARPENTRY

„ A MAN WHO WORKS WITH HIS HANDS IS A LABORER
A MAN WHO WORKS WITH HIS HANDS AND HIS BRAIN IS A CRAFTSMAN
BUT A MAN WHO WORKS WITH HIS HANDS AND HIS BRAIN
AND HIS HEART IS AN ARTIST”

LOUISE NIZER, 1902-1994





WELCOME

WHO WE ARE?

Kolbon Oak Carpentry is a family –run business with a highly skilled, open-minded & creative team. Oak frame designers, engineers, craftsmen and sawmill staff - our people are really our greatest asset. Their experience, skills and Oak frame expertise meld together to provide our clients with truly unique Oak Framed homes & outbuildings that reflect their personalities and enhance their lifestyles.

Our framing yard is situated in a wildest, purest & greenest region in Europe- Beskidy Mountains. Living and working in this incredibly beautiful part of the world gives us a connection to the land and it's forests. This is at the heart of our inspiration and it is echoed in the craftsmanship that goes into each of our unique Oak frame.





WHY OAK?

Oak timber is natural, recyclable and renewable resource. It grows without using artificial energy, and although it must be harvested and transported, the overall use of non-renewable energy is less than concrete or steel. Massive exposed Oak timber celebrates the strength and beauty of the wood. Oak timber frames create buildings of great function, warmth and high performance. Oak timber is not only used for its beauty, but is also an integral part of the building's structure that actually provide strength and support for the building.

Oak has the visual flexibility so it can be used on the most traditional designs, or highly contemporary buildings, where it's combined with modern materials such as glass and stainless steel.

We tend to be environmentally aware and constantly cooperate with Forest Department - our activities harmonize with the model of ecological and sustained forestry practices. Oak timber used in our Oak Frames is from local renewable sources. Much of timber carries the FSC certification, which is only awarded for forests and woodlands that are responsible managed.





ENVIRONMENTAL SUSTAINABILITY

IS SOMETHING WE SINCERELY BELIEVE IN...

At Kolbon Oak Carpentry, building “green” is not just a fashionable marketing manoeuvre, it is the essence of our product.

We sincerely believe in our responsibility to protect the environment that provides so much for us, and we take the steps to ensure our beliefs are put into practice by the way we construct our Oak Frames. From design to manufacturing to construction, what is best for the environment is always taken into consideration right alongside what is best for our client.



ONLY IMAGINATION IS THE LIMIT...

At Kolbon Oak Carpentry your imagination is our inspiration.

As experts in Oak framing , we are fully qualified to turn your dream project into reality.

We specialise in the design and manufacture of traditionally jointed and pegged bespoke Oak Frames which are key to stability, strength, and appearance of the building. Our Oak Frames express the unique aspirations and ideas of our customers, they can be traditional, contemporary or a mixture of both. We don't mass produce standard stock or modular components with computer machined joints. A poor quality sawn finish or skinny frame size is never a feature of our Oak Frames. We craft each and every joint with care and high attention to detail.

As all our Oak Frames are treated individually there is almost unlimited design flexibility. Our bespoke approach to Oak framing means that we won't impose standard designs on you. Every single Oak Frame built by Kolbon Oak is different.

Each is designed & crafted exclusively for you and is a unique reflection of the owner's dreams, without any compromise.

It may take a little longer but ensures that correct Oak components can be worked at the appropriate time to ensure unrivalled quality. What is more the inclusion of chosen bespoke Oak Joinery (windows , doors & staircase etc.) makes any of our Oak framed building truly unique.

You can witness some of the diversity of our work by leafing through this brochure-or see our Web site for more examples of our bespoke approach to Oak framing.



EXPOSED OAK ROOF WITH CURVED TIE TRUSSES AT RENOVATED THE OLD BAKEHOUSE



All these pictures and drawings give an idea of the designs we have previously manufactured and an insight of what we are able to create



BESPOKE L SHAPE OAK FRAMED GARAGE



Inspiration

We look to the past for inspiration, especially the country homes and cottages of Europe, at the same time we are fascinated by contemporary designing where timber is mixed with Stainless Steel, glass & stone.

Oak timber gives us an unique possibility to create both traditional and contemporary building designs or even designs which are seamlessly mix the best of both ancient and modern. It is one of Oak's great strengths that it is an ideally adaptable building material, working equally well across a diverse range of designs.



Garage frame at our workshop





UNCOMPROMISED QUALITY

Kolbon Oak Carpentry knowledge of the art of timber frame design and time-honoured craftsmanship constitute the core of our activity.

Most of us have been involved in every aspect of timber frame construction, from beginning to the end, from milling Oak, through design to fabrication of Oak Frame. One of our greatest strengths is our focus on detail, and this is evident on all of our projects to date. Kolbon Oak Carpentry engineers and draughtsmen ensure that both seen and unseen detail is appropriate and correct.

We believe that the strongest, more durable and most beautiful buildings are a result of selecting exactly the right timber. We consider every beam & joint individually. Having the sawmill on the same site as the frame yard gives us the unique opportunity to select individual round Oak for each project. Working timber in this way, especially oak, requires skills and expertise which cannot be replicated by a machine. This is especially true in most traditional methods of building an oak frame- using joints held together by timber pegs without any hidden supports.

We are committed to our Oak Frame buildings in the same spirit that guided those timberwrights of bygone centuries. Kolbon Oak Carpentry craftsmen are all trained in traditional carpentry. Our toolkits contain a variety of specialist tools largely unchanged for hundreds of years. These are complimented with electric drills, chain morticers and circular saws. Much of the work is finished entirely with hand tools, using time-honoured traditional techniques. We construct Oak Frames with a wide repertoire of structural joints, principally large pegged mortice and tenon joints. Each timber is being scribed and jointed to its neighbours and marked by chisel to identify it at the assembly stage.



CONTEMPORARY & TRADITIONAL
OAK BARN CONVERSION
IN CANTERBURY, KENT.



OUR DESIGN SERVICE

Our experience and knowledge enable us to offer a unique and comprehensive design service to assist you and your project.

Architectural Services, Planning and building Regulations- Using CAD design tools, we can produce plans and models of Oak frames which can be used for making a Planning Application. Communication between the architect, structural engineer or designer on a project is facilitated by a transfer of detailed drawings.

Our design service covers the widest range of possibilities offered by structural carpentry. Our dedicated and experienced team of designers approach each project with informed sensitivity and flexibility. We respect and understand vernacular tradition and history while at the same time take inspiration from contemporary lifestyle. Contemporary designs can be seamlessly blended with the artisan craft of oak carpentry to achieve impressive effect.

Our philosophy is to deliver a design tailor-made to the client's requirements and create structures of space, beauty and function that will improve with age, softening and maturing into the landscapes.

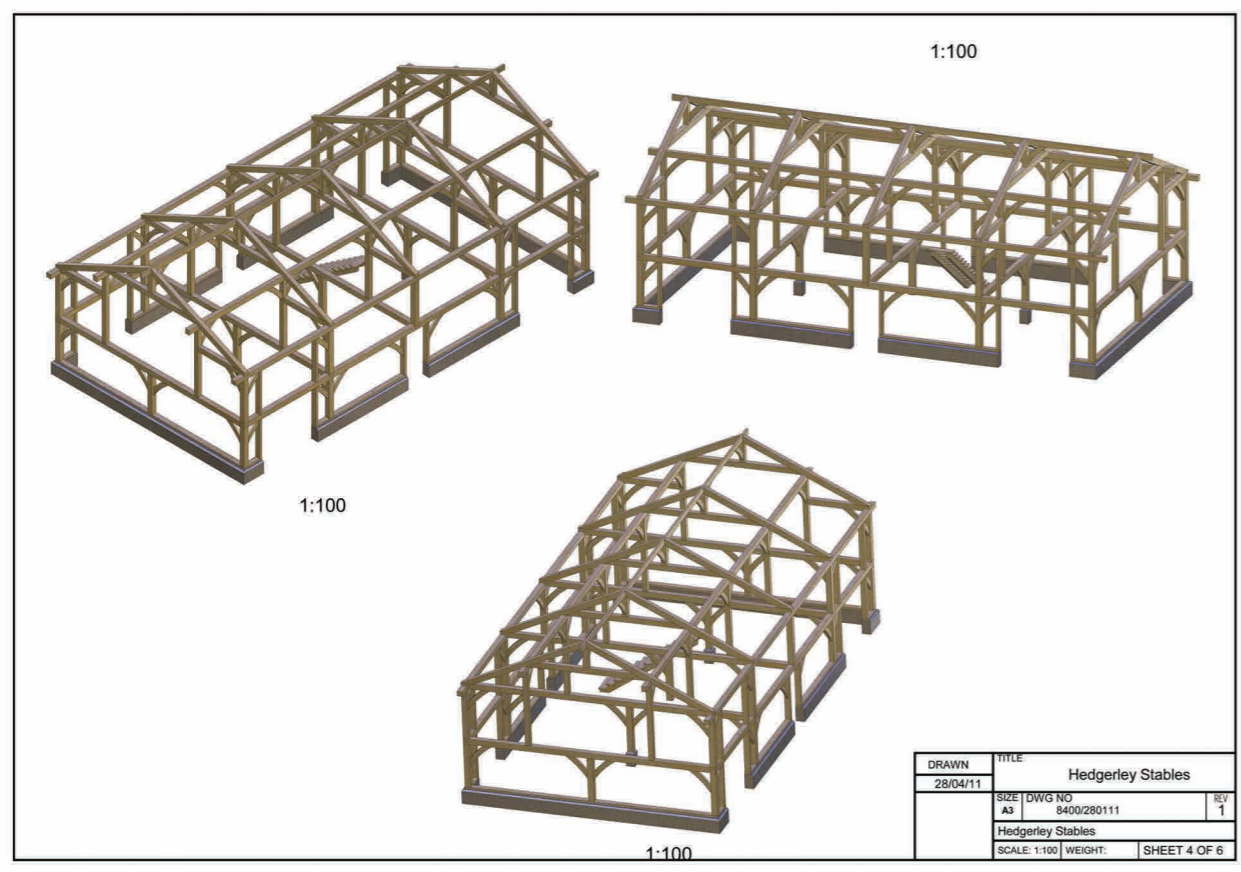
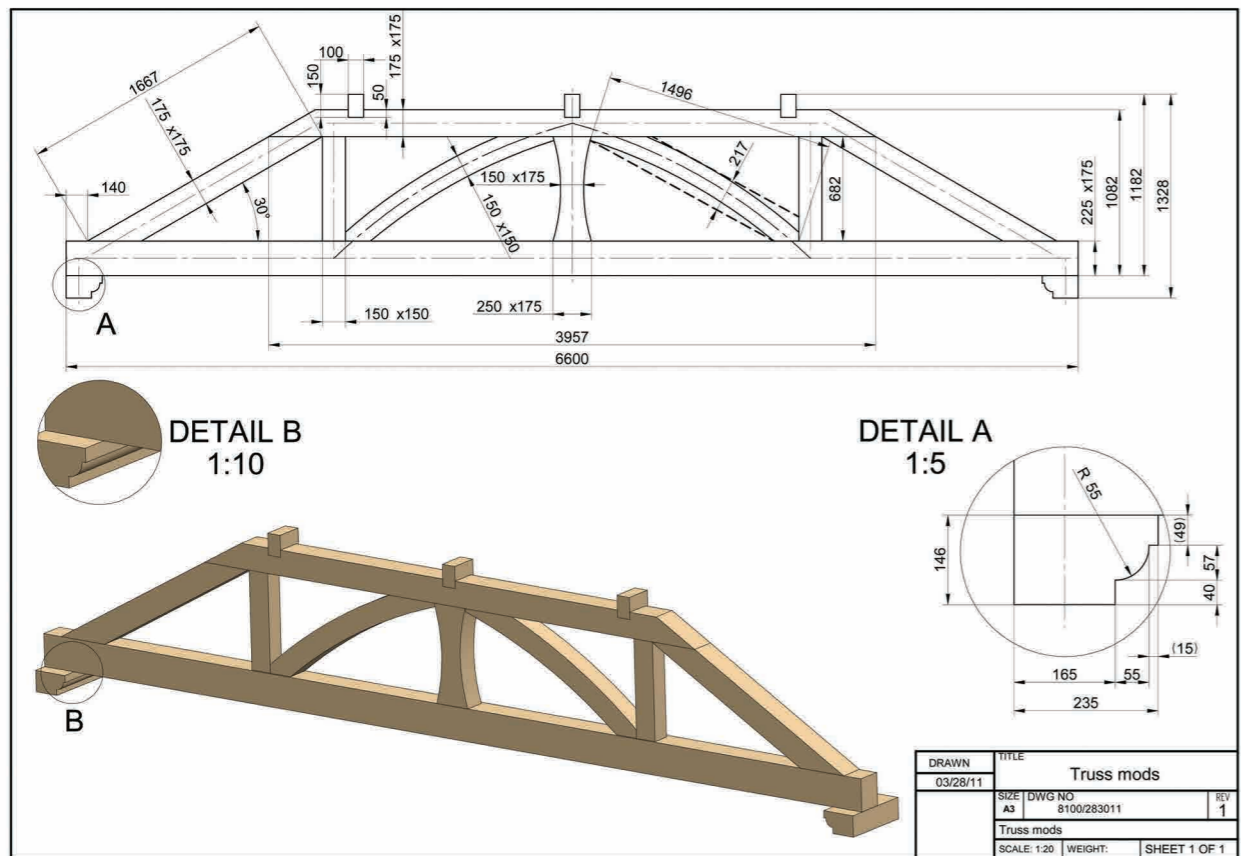

DESIGN IDEAS

1:50

SECTION B-B

W
1:50

5 Bay Garage
with exposed
King Post Trusses

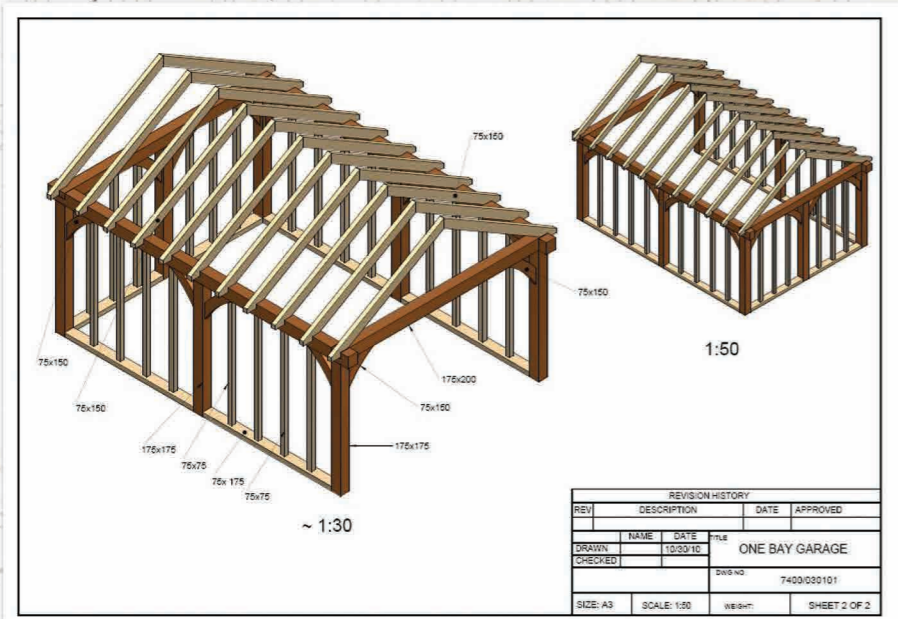
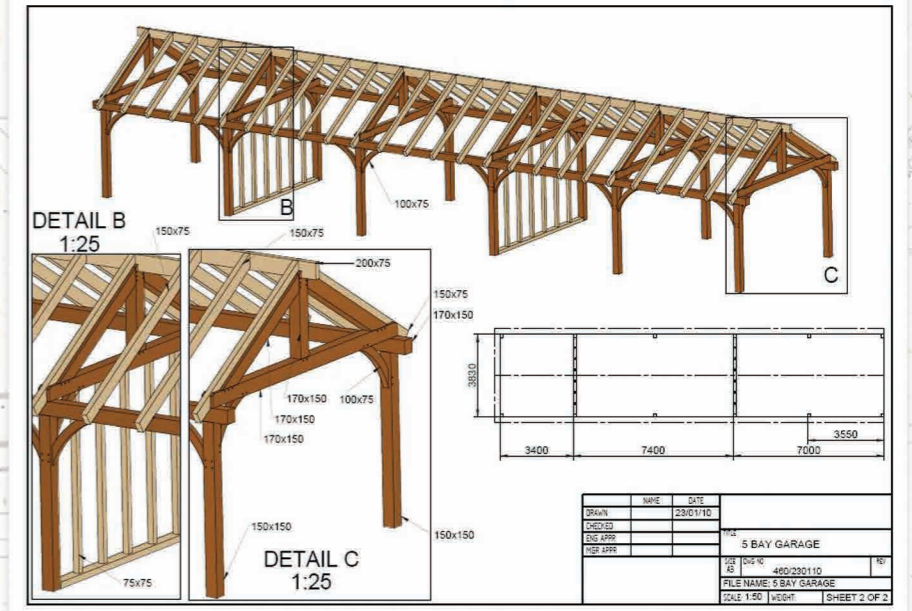

1 Bay Garage

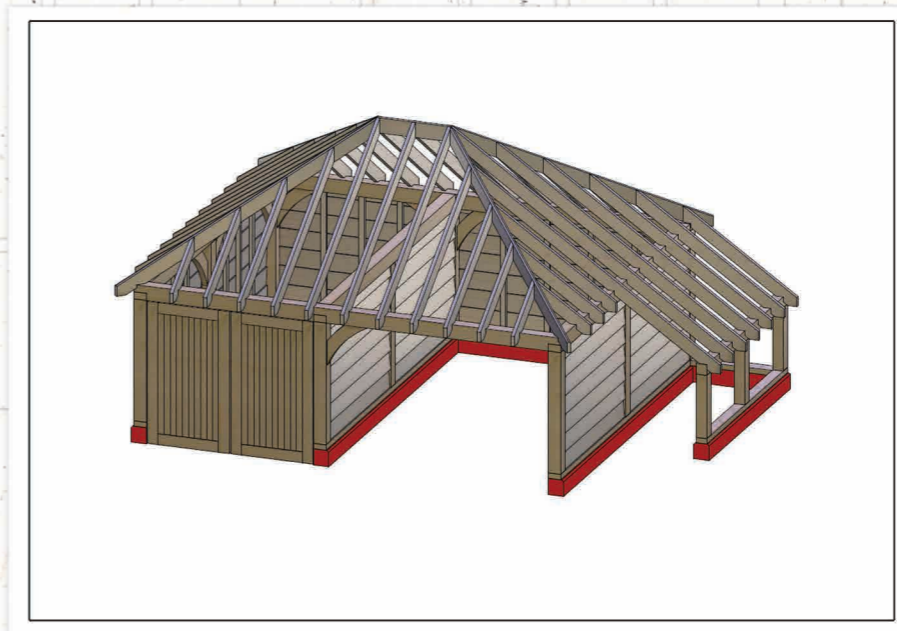

2 Bay Garage
with side isle

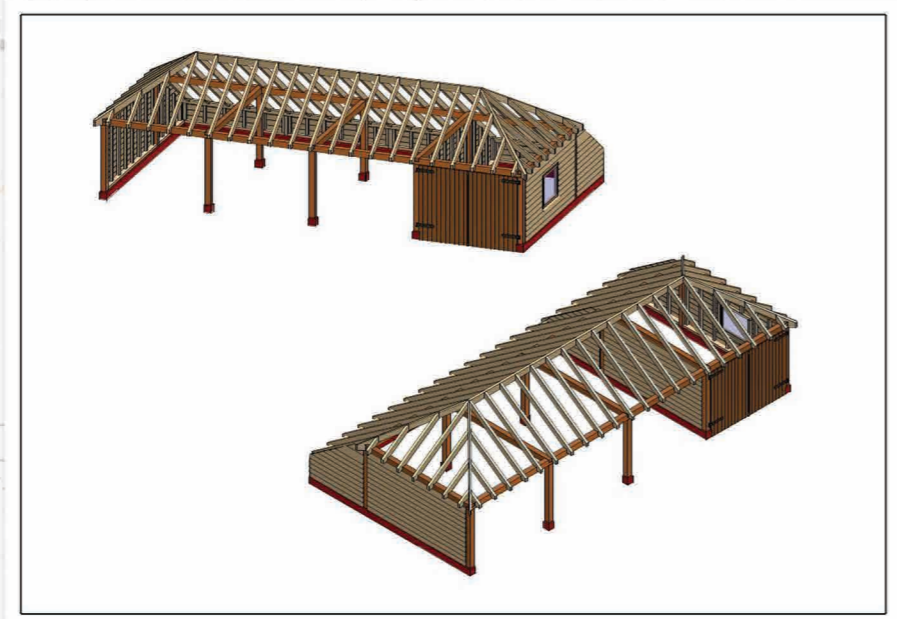

4 Bay Garage, 3 open bays and one closed

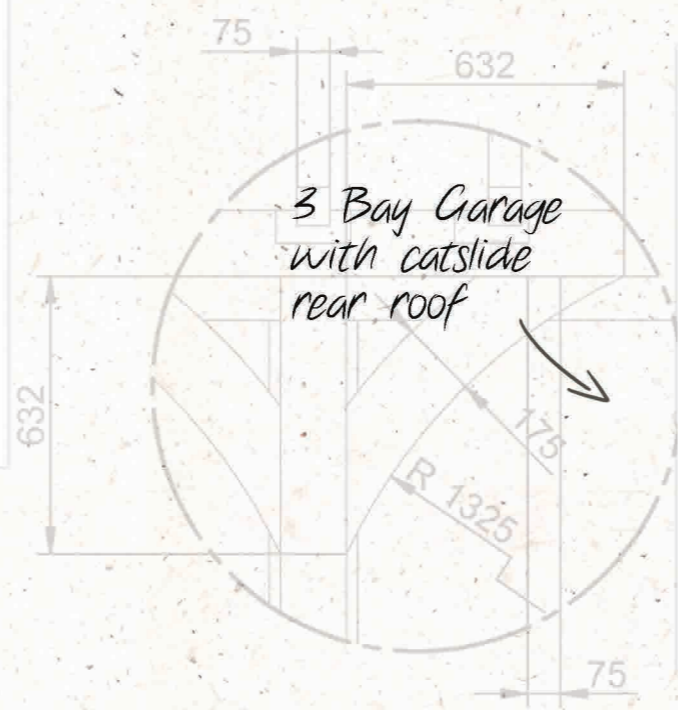

3 Bay Garage
with catslide
rear roof



DETAIL A

SECTION C-C

Garden Room

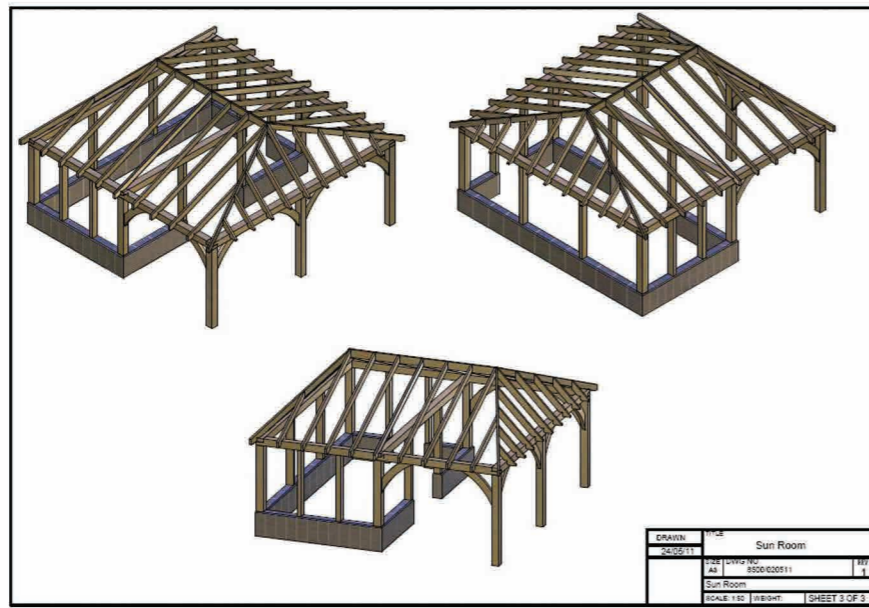

DRAWN	DATE	TITLE
24/05/11		Sun Room
CHECKED	DATE	BY
DESIGN	DATE	TITLE
		Sun Room
REV APPR	DATE	BY
SCALE: 1:50 SHEET 3 OF 3		

SECTION B-B

Two Bay Garage with upper floor

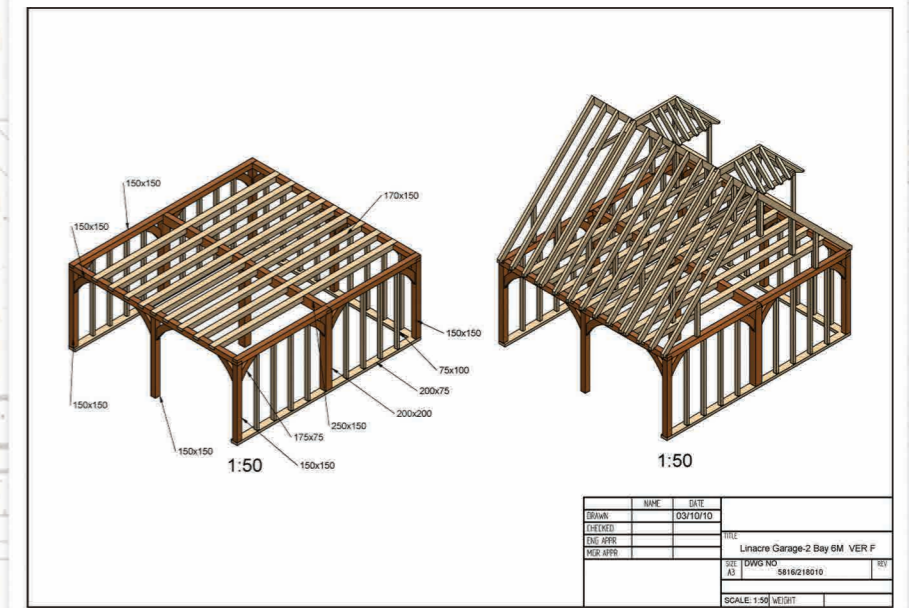

DRAWN	DATE	TITLE
03/10/10		Linacre Garage-2 Bay 6M VER F
CHECKED	DATE	BY
DESIGN	DATE	TITLE
		Linacre Garage-2 Bay 6M VER F
REV APPR	DATE	BY
SCALE: 1:50 SHEET 1 OF 1		

L shape Oak barn with attached office

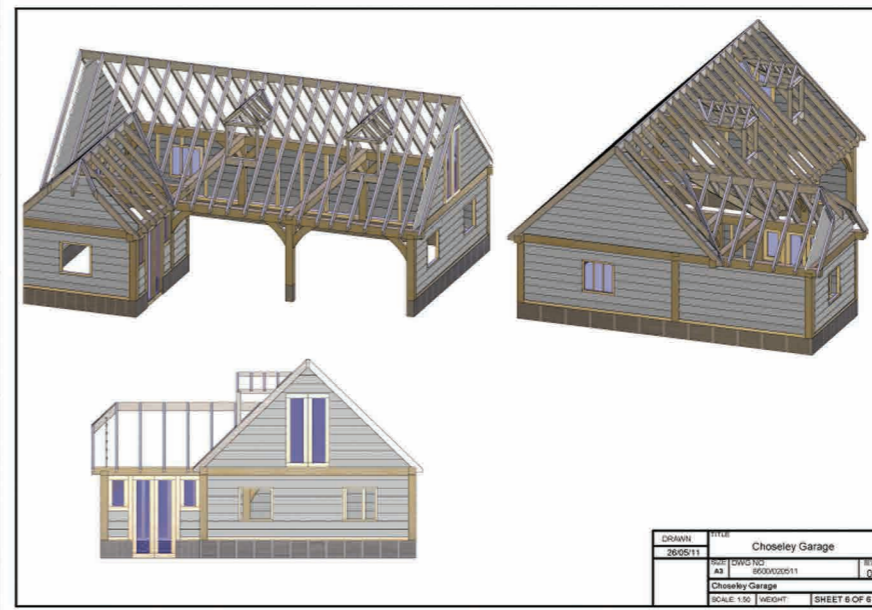

Oak Framed Garage with attached office and playroom above

3 Bay Garage with upper floor

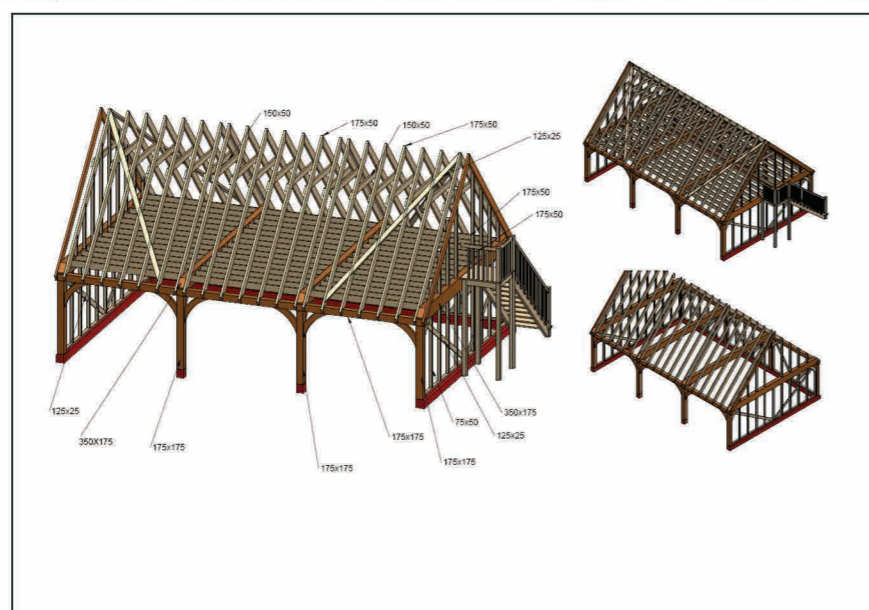

3 Bay Garage with catslide rear roof

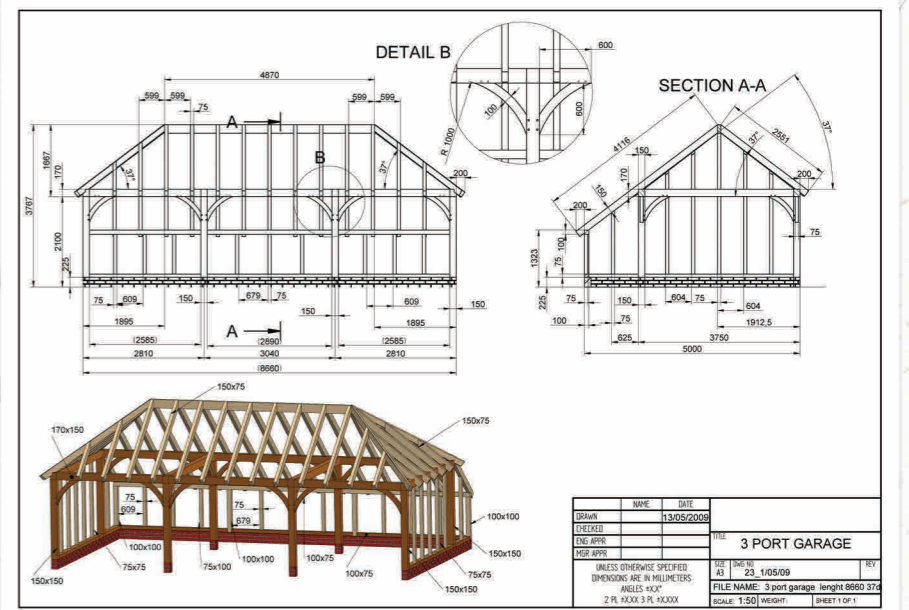

DRAWN	DATE	TITLE
13/05/2009		3 PORT GARAGE
CHECKED	DATE	BY
DESIGN	DATE	TITLE
		3 PORT GARAGE
REV APPR	DATE	BY
UNLESS OTHERWISE SPECIFIED DIMENSIONS ARE IN MILLIMETERS ANGLES 90°		
FILE NAME: 3 port garage length 6660 374		
SCALE: 1:50 SHEET 1 OF 1		

DETAIL A

OAK FRAME GARDEN ROOM WITH HANDCRAFTED OAK BI-FOLD DOORS

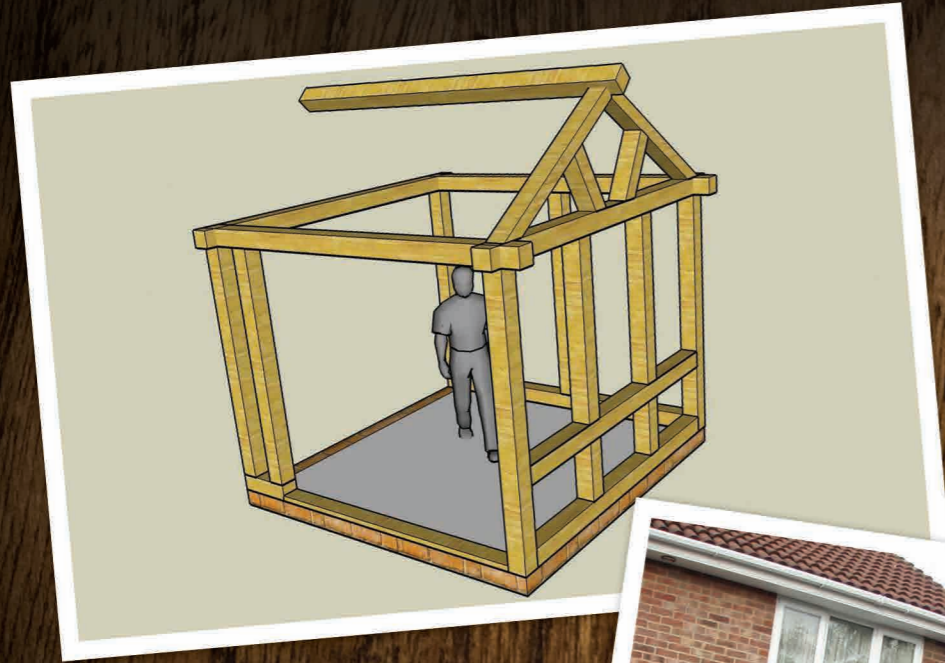

BEAUTIFUL AND UNIQUE
4 BAY OAK FRAME GARAGE
WITH GARDEN ROOM



HANDCRAFTED FUNCTIONAL OAK FRAME WORKSHOP

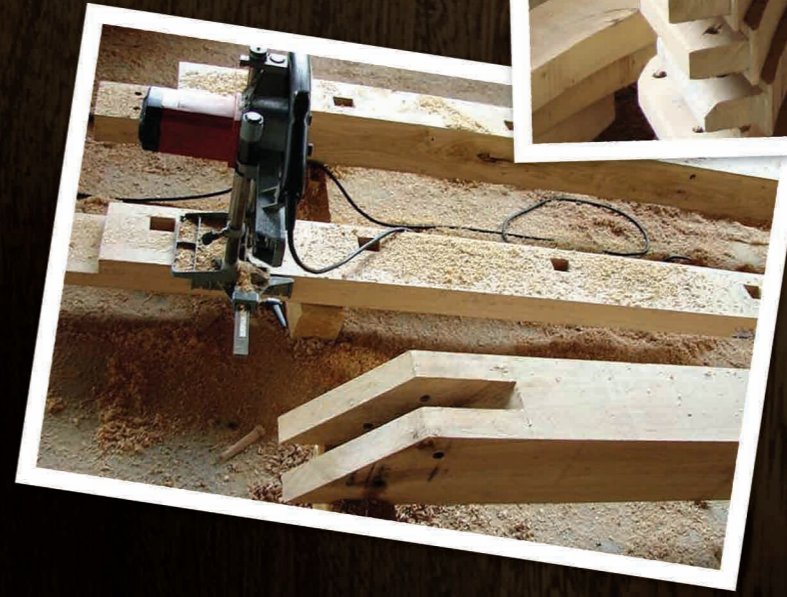

OUR PRIDE
IS IN EVERY OAK FRAME WE BUILD...

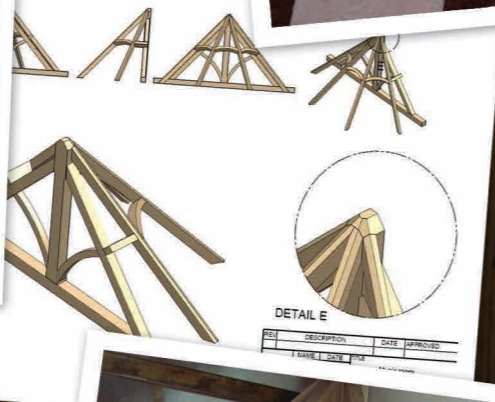
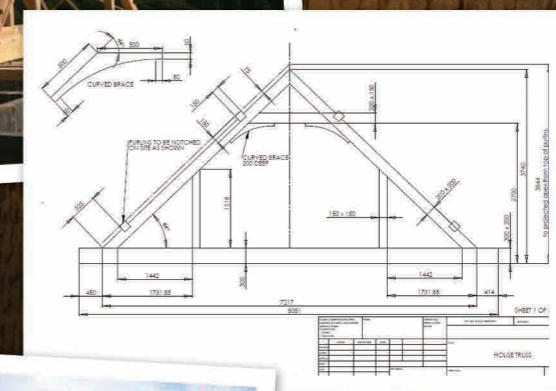
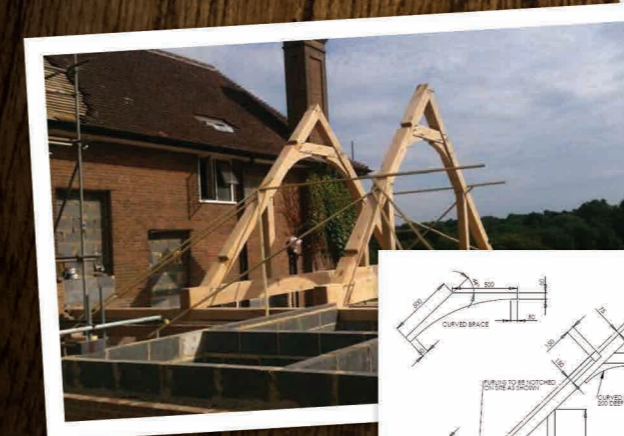
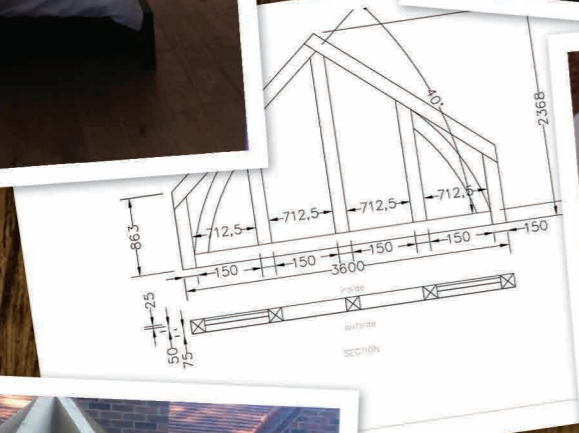
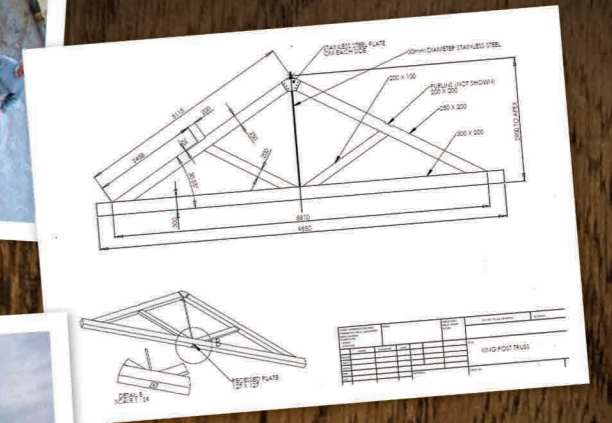



Kolbon Oak Carpentry craftsmanship is the quality that comes from designing and creating our Oak Frames with passion, care, and attention to detail.



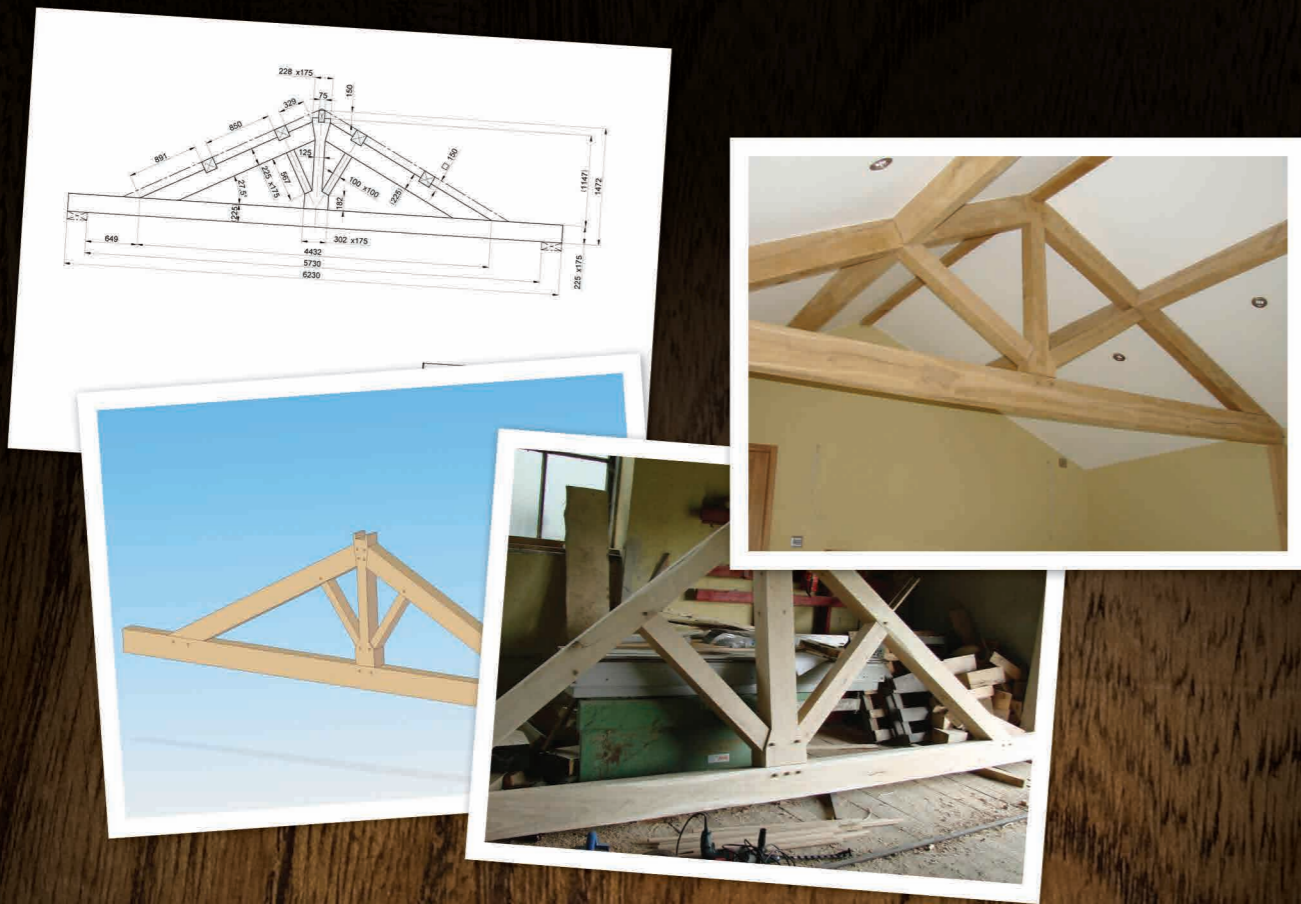

Our bespoke Oak Framed buildings include home offices, garages, barns, extensions, pools and garden rooms. We are able to design unique versions of all of these types of buildings giving a quality solution to your individual needs. Whether you have a heart set on oak framed extension, outbuilding or a whole house we are always ready to help you. We believe that adaptability and stability of an Oak Frame can match to almost any requirements whilst adding an ageless beauty that blends it gracefully whenever it is placed.

Thank you for your interest in Kolbon Oak Carpentry and look forward to working with you in the very near future.

If you wish to contact us directly we can be reached by phone on 0048 502654278 or by fax on 0048 184457228, 0048 184457091.

You can e-mail a planning or general enquiry to:

enquiries@kolbonoakcarpentry.co.uk

Our website is useful place to discover more about our activities past and present:

www.kolbonoakcarpentry.co.uk

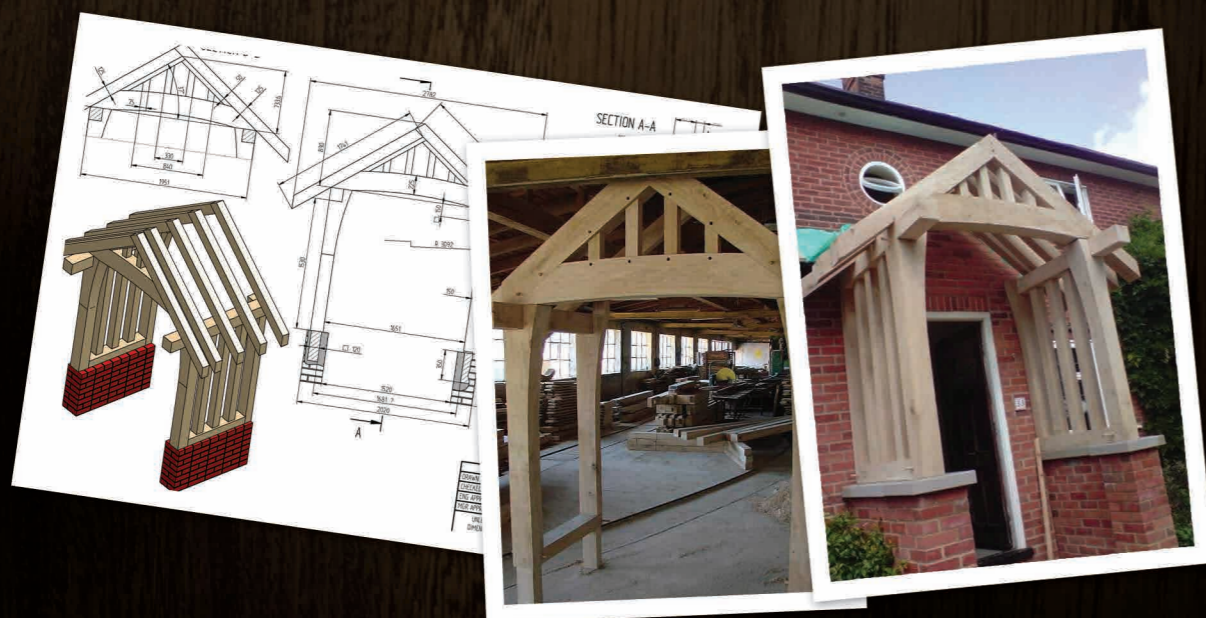



KOLBON OAK CARPENTRY, REGISTERED OFFICE:
NAWOJOWA 709/33-335 NAWOJOWA, POLAND

TEL.: +48 50 265 4278, TEL: +48 18 445 7228, FAX: +48 18 445 7091

E-MAIL: ENQUIRIES@KOLBONOAKCARPENTRY.CO.UK
INFO@KOLBON-OAK-FRAME.CO.UK
WEB: WWW.KOLBONOAKCARPENTRY.CO.UK

PROTECTING THE ENVIRONMENT STARTS WITH LITTLE STEPS.
PLEASE PRINT WHEN NECESSARY.

